

Genogram Template

Name: John Doe





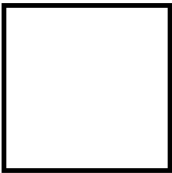
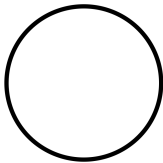
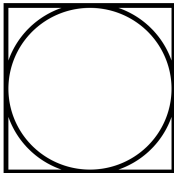
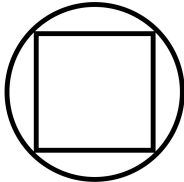

Date: 28 Nov 2023

Symbols Key:

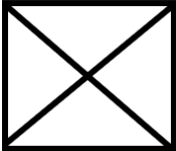



Gender Symbols

Male 	Female 	Transgender F-M 	Transgender M-F 
--	---	--	--

Lifespan Symbols

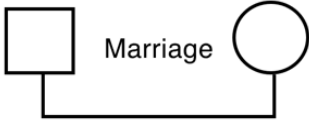
Deceased  	Age at Death  	Birth Year - Death Year '79  '69 - '98 
--	---	--

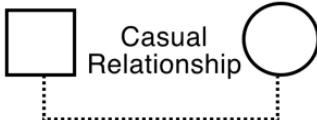
Relationship Types

Married 	Committed Relationship 	Casual Relationship 	Temporary Sexual Relationship 
---	---	---	--

Children Symbols

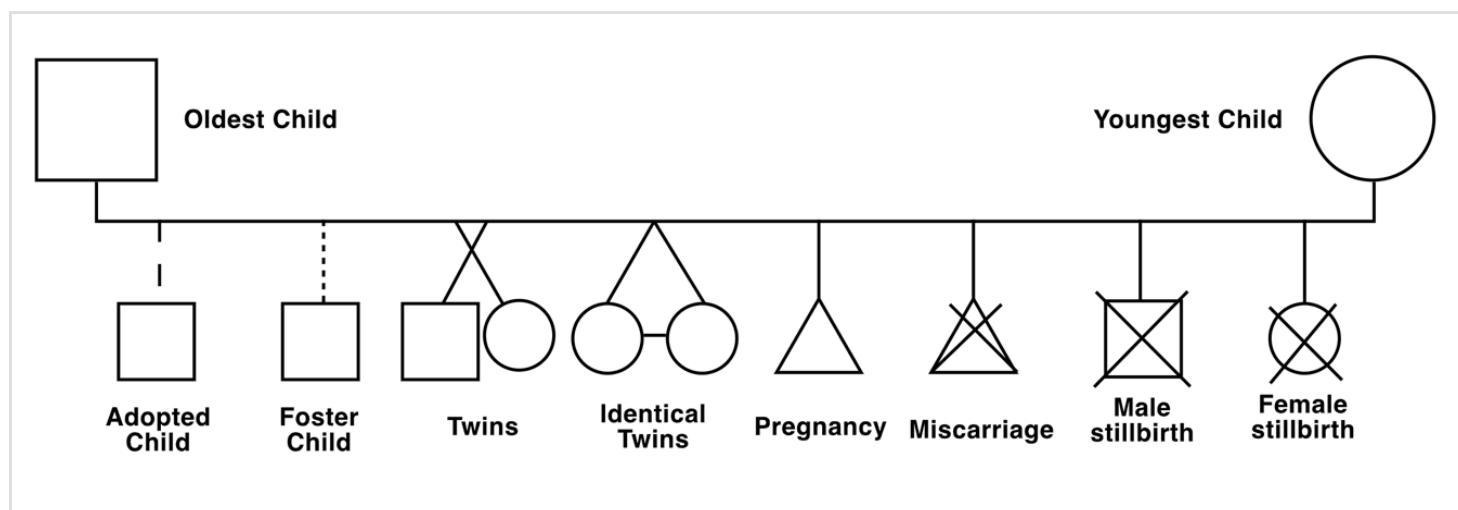

Relationship Events

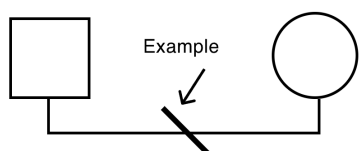

Divorced 	Separated 	Widowed 	Cohabitation
--------------	---------------	-------------	------------------

Emotional Relationships

Normal 	Indifferent 	Distant 	Estranged
Friendship 	Very Close 	Conflictual 	Emotional Abuse
Sexual Abuse 	Physical Abuse 	Neglect 	Fused

Grid Area

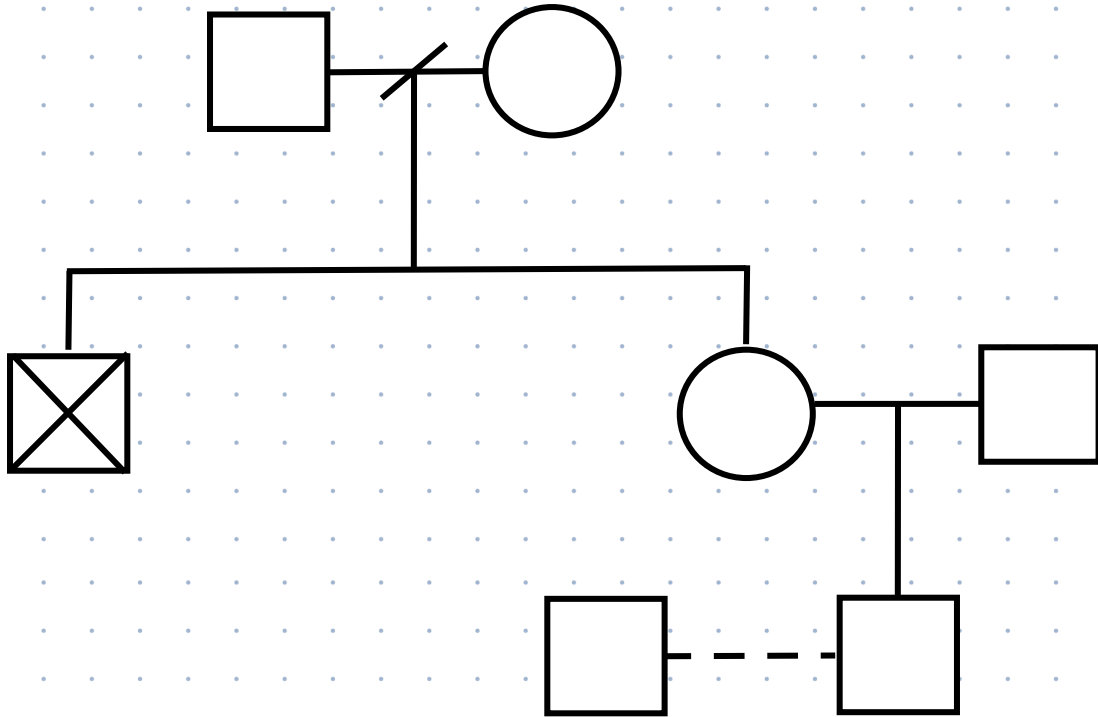

Notes section:

To be completed next session;