

3 Generation Genogram

Name of Family Tree: _____

Gen 3

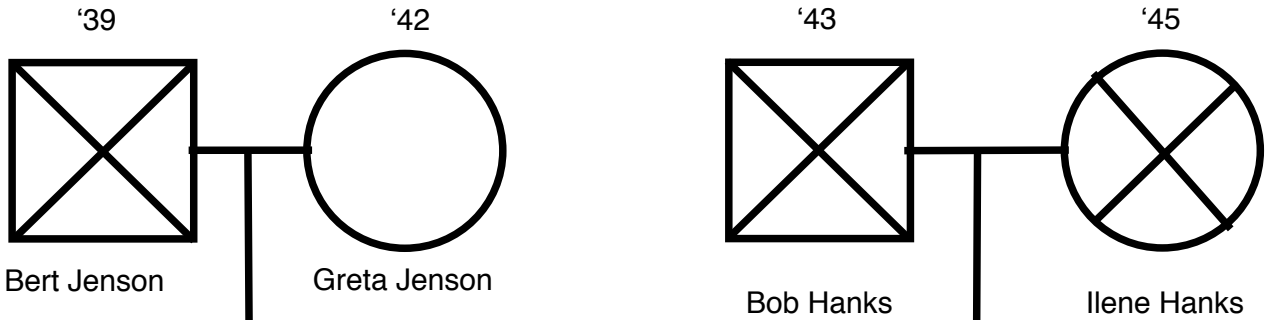

Gen 2

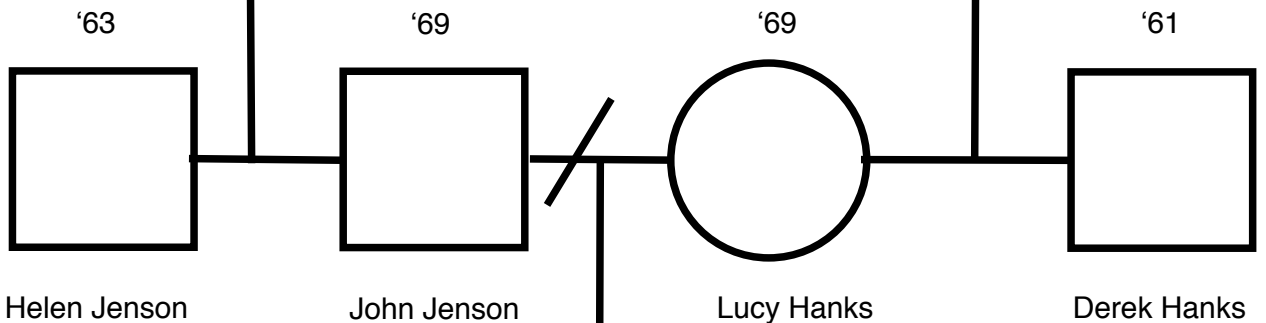



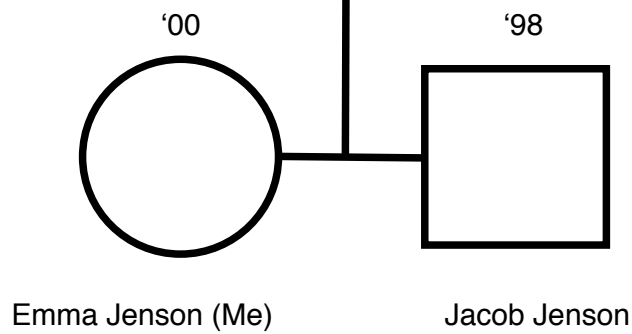



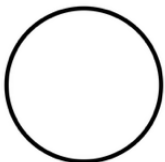
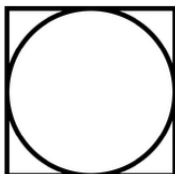
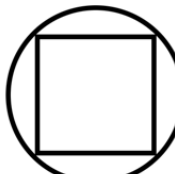

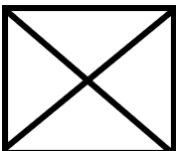
Gen 1

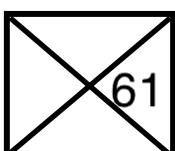

Symbols Key:

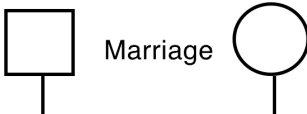

Male 	Female 	Transgender F-M 	Transgender M-F 
--	---	--	--

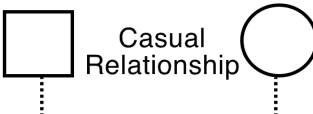
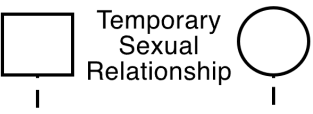

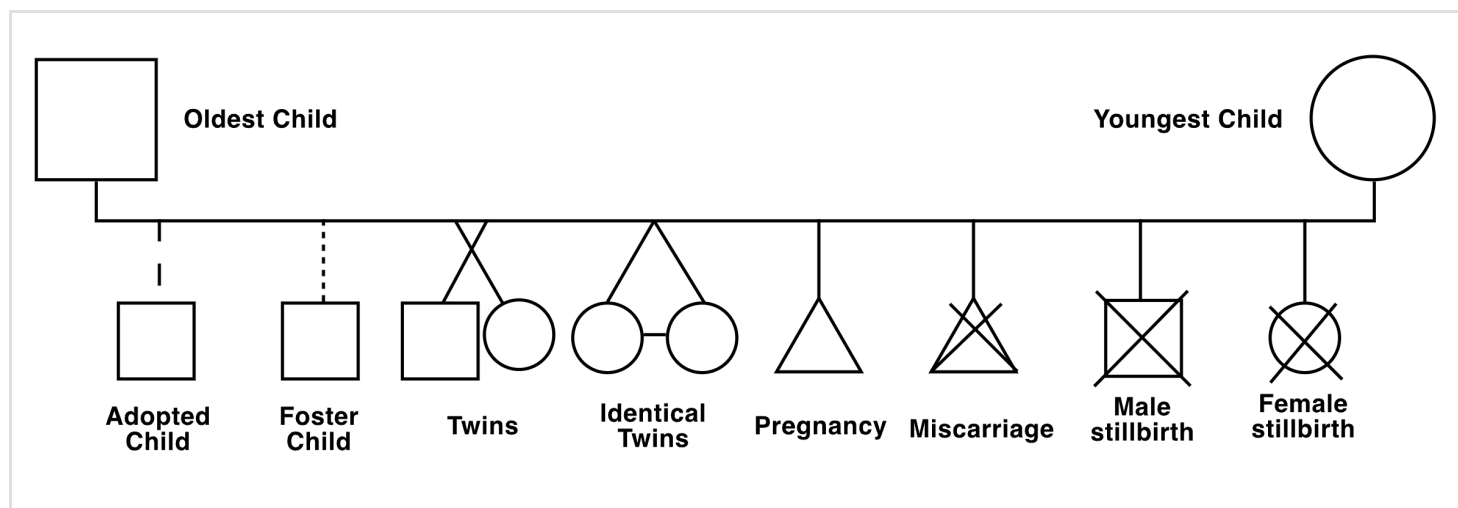

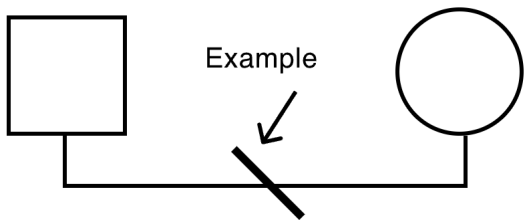

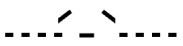

Deceased  	Age at Death  	Birth Year - Death Year '79  '69 - '98 
--	---	--

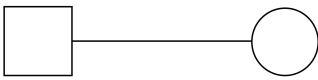
Married 	Committed Relationship 	Casual Relationship 	Temporary Sexual Relationship 
--	--	--	---



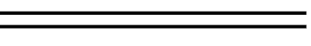

Divorced 	Separated 	Widowed 	Cohabitation 
---	--	---	---

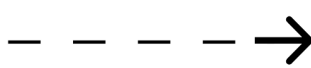
Normal 	Indifferent 	Distant 	Estranged 
Friendship 	Very Close 	Conflictual 	Emotional Abuse 
Sexual Abuse 	Physical Abuse 	Neglect 	Fused 